

# OS-300-5

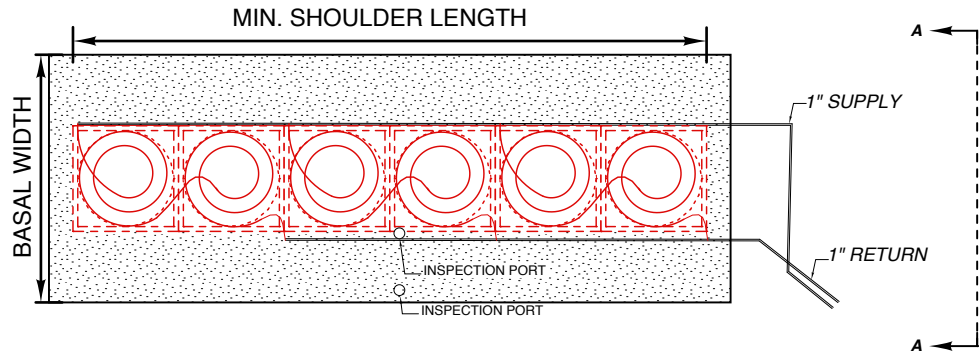

**Plan View**  
NTS

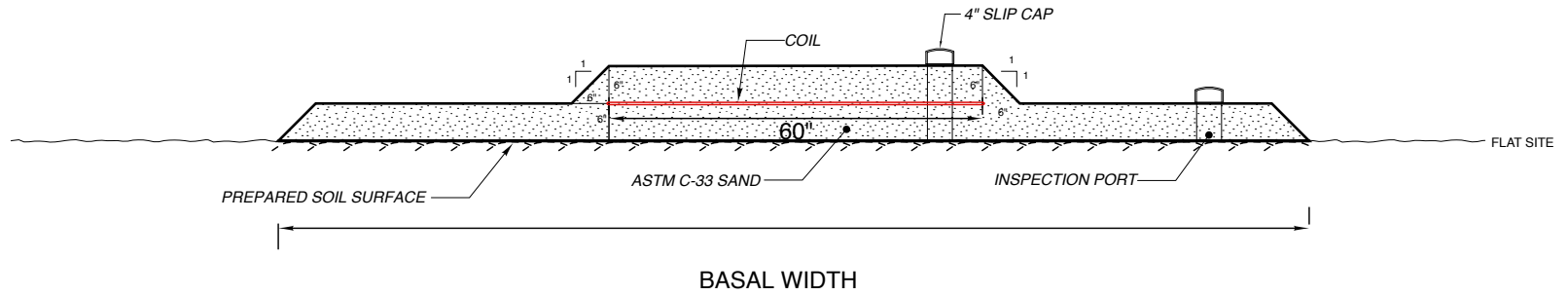

**Section A**  
NTS